

## IRRIGATION CHALLENGES IN NORTH – WEST GREECE: PERSPECTIVES AND SOLUTIONS FOR FLOOD PRONE REGIONS

**D. SERBIS, C. PAPATHANASIOU, and N. MAMASSIS**

Laboratory of Hydrology and Water Resources Management, School of Civil Engineers,  
National Technical University of Athens, 5 Heron Polytechneiou str., 157 80, Athens,  
Greece

e-mail of corresponding author: [papathanasiou@chi.civil.ntua.gr](mailto:papathanasiou@chi.civil.ntua.gr)

### EXTENDED ABSTRACT

Multiple water needs in rural areas together with poor water resources management are often posing serious threats to the environment and can cause rapid depletion of water resources. Irrigation, an activity that accounts for 44% of total water use in Europe, a share that can reach up to 80% in parts of southern Europe, is significantly affected by water scarcity with far reaching social, economic, environmental and demographic impacts. In many rural areas excessive groundwater use for irrigation in conjunction with obsolete water practices are among the key factors responsible for the depletion of water resources. Significant water losses also occur through outdated irrigation networks and structural deficiencies on water conveyors. Moreover, environmental hazards are intensified in agricultural areas lacking appropriate flood mitigation structures. In these cases, during flood events, fertilizers and other contaminants are easily spread over large areas posing permanent treats to ecosystems and natural resources. This paper presents a holistic water resources management approach towards adequate flood protection of rural areas, while at the same time reversing the depletion of overexploited local underground resources. More specifically, a series of technical works including two interconnected reservoirs and a number of small detention ponds are proposed to protect an irrigated area of 1.900 ha which is frequently devastated by floods. Water from the detention reservoirs will also be used to cover irrigation needs of the cultivated areas, which currently overuse underground resources. At the same time, reservoir water will be used to irrigate an adjacent area of extra 1.900 ha, with no other available water recourses, thus extending arable land to 3.600 ha in total. It is also proposed to exploit the considerable height difference (275 m) between the two reservoirs for electricity production. Stopping water pumping for irrigation will return groundwater table to its natural level, a process which is expected to take several years to complete. A list of other structural and non-structural measures is also proposed to further improve water management in the area.

**Keywords:** Water resources management, rural areas, hydraulic works, dams, reservoirs, flood risk management, groundwater depletion, hydropower

## 1. INTRODUCTION

Excessive water use, growing demand and variations in temperature range and rainfall patterns due to climate change are posing serious threats to the environment and are depleting water resources.

Water scarcity is particularly affecting irrigation, an activity that accounts for 44% of total water use in Europe, a share that can reach up to 80% in parts of southern Europe (EEA, 2009), with far reaching social, economic and demographic impacts (UNU-INWEH, 2013). Globally, it is estimated that annual agricultural water use will need to increase from approximately 7,100 km<sup>3</sup> to between 8,500 and 11,000 km<sup>3</sup> in order to meet projected food requirements in 2050 (de Fraiture et al., 2010).

Furthermore, agricultural activities are indicated as posing a severe pressure on water bodies both as a diffuse or point pollution source, by 90% of the River Basin Management Plans (RBMP), one of the most important instruments for the implementation of the Water Framework Directive (WFD) 2000/60/EC (EC, 2012).

Environmental hazards are intensified in flood prone areas, where fertilizers and other contaminants can be easily spread over large regions posing permanent treats to ecosystems and natural resources.

A holistic approach is therefore needed for effective water management solutions especially in flood prone river basins where agricultural water use is dominant.

## 2. METHODOLOGY

Boida-Mavri plain is located in north-west Greece and extends over 4.000 ha, 1.900 ha of which are irrigated by a network constructed during 1981 – 1983. The area is drained by a trapezoidal ditch which proves insufficient during flood events (Fig. 1).

In order to protect irrigated areas from floods, a series of measures have been suggested, including *inter alia*, widening of existing channels, the construction of a new drainage ditch, the construction of a drainage tunnel and the construction of an attenuation dam, 12 m high (Fig. 2).

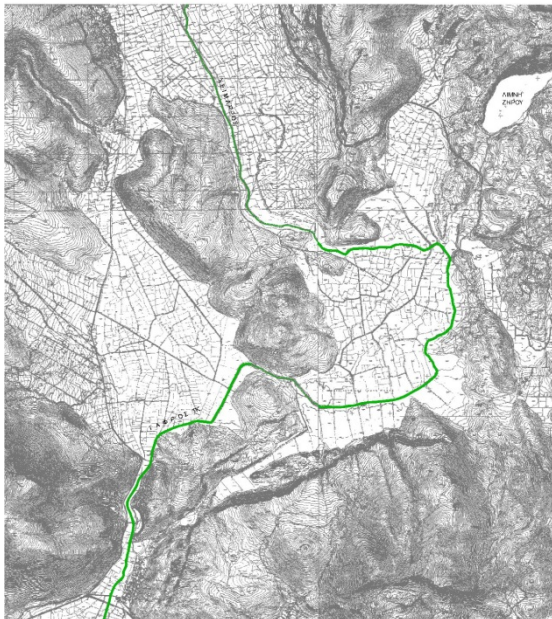

Fig. 1: Current status of the area

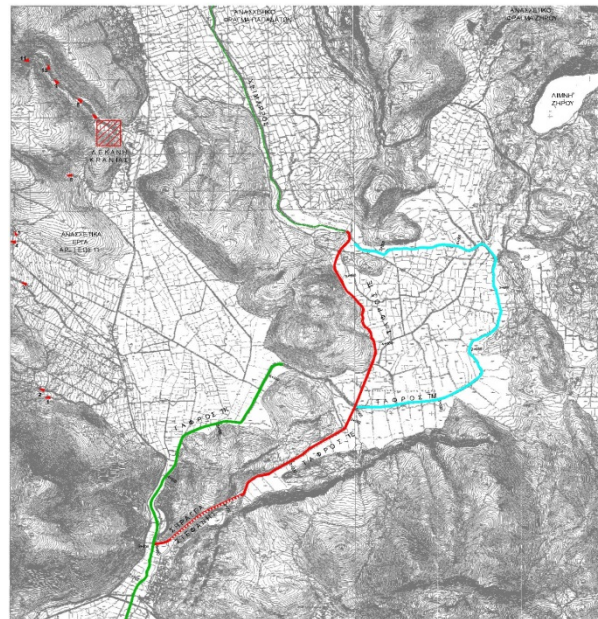

Fig. 2: Flood protection works

During the design phase of these works, it has been proposed to convert the 12 m high attenuation dam into a 75 m high multi-purpose dam, in order to: a) use water from the reservoir to irrigate cultivated fields extending over 1.900 ha that are currently pumping water to cover their needs and b) irrigate an extra 1.900 ha located in the immediate vicinity downstream of the proposed location of the dam that are not currently cultivated due to water shortages (Fig. 3). It should be noted that the new design will continue to provide the same level of flood protection to downstream areas as would the attenuation dam it is proposed to replace.

The proposed reservoir could be further enlarged by additional works that will convey water from an adjacent river basin in order to increase its volume by  $6.7 \times 10^6 \text{ m}^3$ . A supplementary dam 30 m high is foreseen for this purpose that will create a re-regulating reservoir of  $0.99 \times 10^6 \text{ m}^3$ . Water from the supplementary reservoir will be conveyed to the main reservoir by a 16.4 km long pipe. The considerable height difference (275 m) between the two reservoirs can be used for the production of hydroelectricity (Fig. 4).

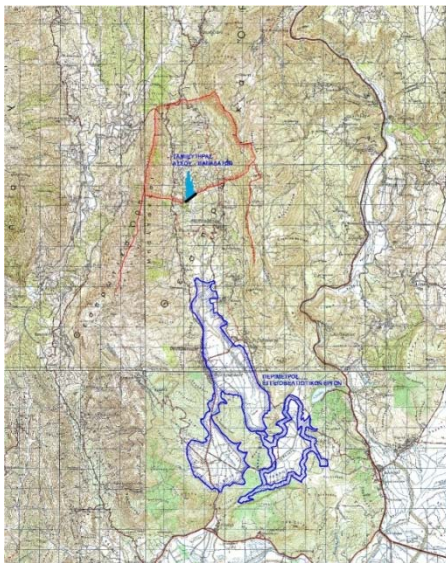

Fig. 3: River basin of the proposed dam and boundaries of the irrigated areas

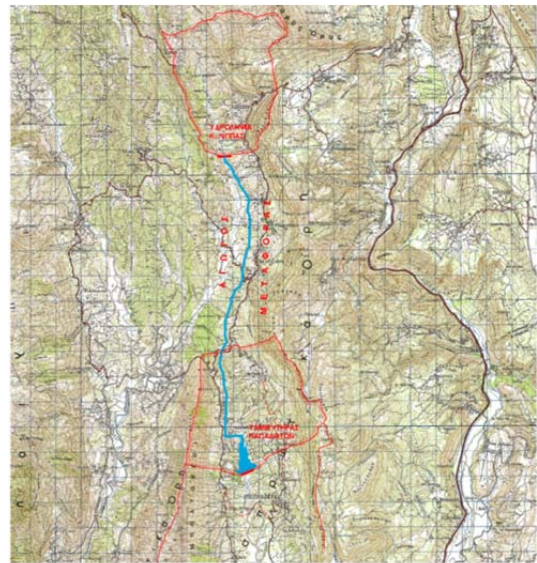

Fig. 4: River basins of the proposed main and supplementary dams

### 3. RESULTS

Plan and section views of the proposed main dam are presented in figures 5 and 6 respectively.



Fig. 5: Plan view of the main dam

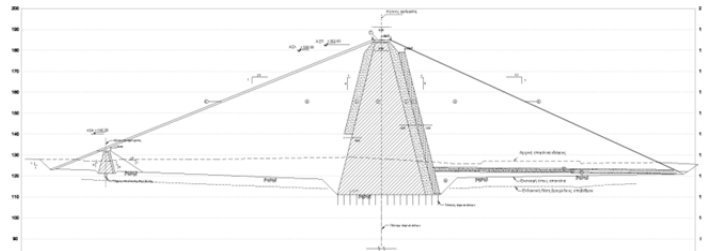

Fig. 6: Section view of the main



Both the main and the supplementary dams will be earth dams constructed with local materials found within their river basins. The main geometrical characteristics of the main and the supplementary dams are presented in the following table (Serbis, 2009).

Proposed works		Main dam	Suppl. dam
Dam	Height (m)	75.00	30.00
	Length (m)	800.00	244.00
	Volume (m <sup>3</sup> )	3.65×10 <sup>6</sup>	0.23×10 <sup>6</sup>
Reservoir	Total capacity (m <sup>3</sup> )	14.36×10 <sup>6</sup>	0.99×10 <sup>6</sup>
	Inactive storage (m <sup>3</sup> )	0.60×10 <sup>6</sup>	0.20×10 <sup>6</sup>
	Active storage (m <sup>3</sup> )	13.76×10 <sup>6</sup>	0.79×10 <sup>6</sup>
Spillway	Inflow peak flow (m <sup>3</sup> /s)	403	293
	Inflow design flow (m <sup>3</sup> /s)	283	224
	Return period (years)	1:10.000	1:1.000
	Design head (m)	2.63	2.53

An appropriate spillway has been designed for an inflow design flow (IDF) of 283 m<sup>3</sup>/s, calculated for a return period of 10.000 years (Fig. 7). IDF was calculated by taking into consideration flood routing within the reservoir and the spillway, which reduces inflow peak flow from 403 m<sup>3</sup>/s to 283 m<sup>3</sup>/s, as it can be seen in Fig. 8.

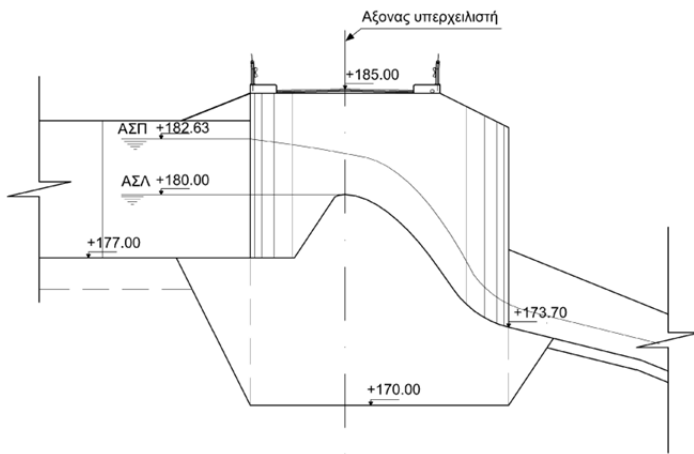

Fig. 7: Spillway profile

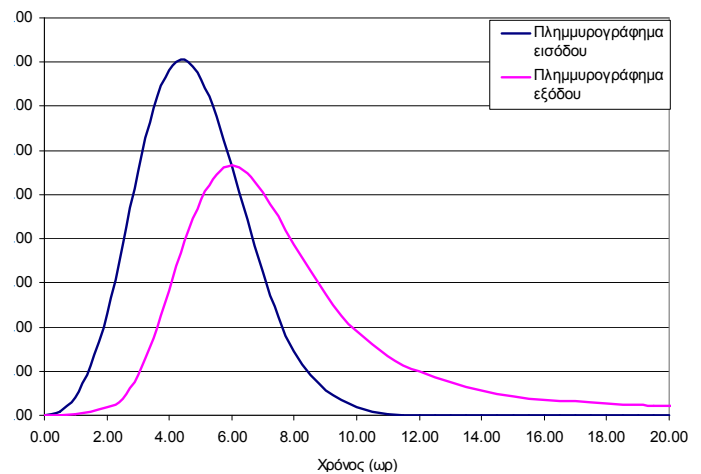

Fig. 8: Reservoir flood routing

It should be noted that in order to provide the same level of flood protection, the multi-purpose dam must maintain an empty volume of 571.000 m<sup>3</sup> during winter, to accommodate flood inflow.

To further reduce flood risks a number of non-structural measures have also been considered for the area, including public awareness raising campaigns and regular cleaning of the drainage channels, in order to maintain the roughness characteristics for which they have been designed (Serbis *et al.*, 2013).

#### 4. DISCUSSION AND CONCLUSIONS

A holistic approach for efficient water management in a river basin was presented in which a flood protection structure was converted to a multi-purpose dam with significant environmental and economic benefits.

More specifically the proposed works are expected to provide adequate flood protection in a flood prone area and at the same time supply enough water to irrigate an area of 3.600 ha. The proposed works will prevent water abstraction from underground resources that are being overexploited and have a significant operational cost. Currently 7 pumping stations of a total capacity of 3.140 m<sup>3</sup>/h are supplying irrigation ditches in order to cover the needs of the cultivated areas extending over 1.900 ha. Additional water volumes are also abstracted from the banks of several watercourses in the area, including the main river of the area (river *Louros*), which has its estuary in the *Amvrakikos* bay, a protected area part of the Natura 2000 network.

By providing enough water to cover the irrigation needs of the entire plain (3.600 ha), the proposed works will assist in the replenishment of groundwater resources and in ameliorating the physical and chemical conditions of both local watercourses and the protected areas. Further environmental benefits arise from the fact that water in the reservoir will be collected mainly during the winter and as a result local water resources that are currently used for irrigation will return to natural watercourses when are more needed *i.e.* during summer time. In other words, the creation of the proposed works will regulate the current temporal as well as the spatial distribution of water resources with significant environmental benefits.

Significant hydropower can be also produced by exploiting the considerable height difference between the 2 proposed reservoirs (275 m).

Regarding the environmental impact of the works, the full environmental assessment that has been undertaken during the design study of the works, examined all possible consequences on water resources and the environment. The proposed works are described in the River Basin Management Plan that has been prepared under the Water Framework Directive for the Epirus Water District (RBMP, 2013). According to the RBMP activities associated with the proposed works do not lower local water bodies status and are therefore not included under Article 4.7 of the Water Framework Directive, which refers to exemptions to the environmental objectives set for all water bodies.

#### REFERENCES

- de Fraiture, C., Molden, D. and Wichelns, D., (2010), *Investing in water for food, ecosystems, and livelihoods: An overview of the comprehensive assessment of water management in agriculture*, Agricultural Water Management Vol. 97, pp. 495-501.
- European Environment Agency, (2009), *Water resources across Europe — confronting water scarcity and drought*, Report No 2/2009.
- European Commission, (2012), *Final report from the Commission to the European Parliament and the Council on the Implementation of the Water Framework Directive (2000/60/EC) River Basin Management Plans*, EUROPEAN COMMISSION Brussels, 14.11.2012 670.
- River Basin Management Plans (2013), *Water District of Epirus*, Special Secretariat of Water, Ministry of the Environment and Climate Change
- Serbis, D., Papathanasiou, C. and Mamassis, N., (2013), "Flood mitigation at the downstream areas of a transboundary river", *Proc. 8<sup>th</sup> International Conference of EWRA "Water Resources Management in an Interdisciplinary and Changing Context"*, 26<sup>th</sup>-29<sup>th</sup> June 2013, Porto, Portugal.
- Serbis, D., (2009), *Preliminary Design of the Papadates Dam*, MEYP Consultants, Ministry of Rural Development and Food.