

Renewable Energy & Hydroelectric Works

8th semester, School of Civil Engineering

2nd semester, Master's Programme "Water Resources Science & Technology"

Aeolic energy



Andreas Efstratiadis

Department of Water Resources & Environmental Engineering, NTUA

Academic year 2022-23

Aeolic (wind) energy in a nutshell

- ❑ Renewable energy source, driven by the **kinetic energy of wind**.
- ❑ Wind → complex atmospheric process, overall driven by **solar activity**.
- ❑ Wind energy is a **nonlinear transformation of wind speed**.
- ❑ Wind speed exhibits significant variability at all spatial and temporal scales, thus the energy produced by wind is also **randomly varying** and **unpredictable**.
- ❑ The efficiency of an **ideal wind turbine** (= conversion of kinetic energy of wind to mechanical energy) is bounded to a theoretical upper value, known as **Betz limit**, which equals $16/27 = 59.3\%$.
- ❑ The **actual efficiency** of a real-world turbine (= conversion of kinetic energy of wind to electricity) is quite less than the Betz limit and varies across feasible wind speed values, typically ranging from **3.5 to 25.0 m/s**.

- ❑ Worldwide wind power capacity: 845 GW (102 GW added in 2021)
- ❑ Greece: 4.68 GW
- ❑ Mean global share: 6.7% (from only 2.0% in 2011)
- ❑ Highest share: Denmark (48%)
- ❑ Largest wind farm: Gansu Wind Farm, China (7000 turbines, 10 GW)

Estimated Renewable Energy Share of Global Electricity Production, End-2019

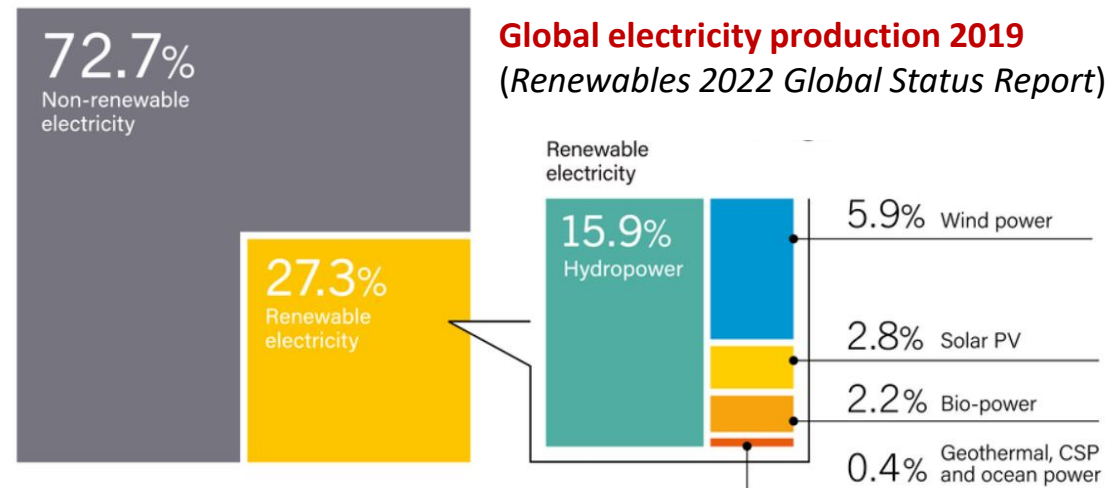

Overview of wind processes

- ❑ Wind is caused by **differences in the atmospheric pressure**; air moves from the **higher to the lower pressure areas**, resulting in winds of various speeds. On a rotating planet, air is also deflected by the **Coriolis effect**, except exactly on the equator.
- ❑ Globally, the two major driving factors of large-scale wind patterns (the atmospheric circulation) are the **differential heating between the equator and the poles** (difference in absorption of solar energy leading to buoyancy forces) and the **rotation of the planet**.
- ❑ Typically, term wind refers to **horizontal movement of air**; differences in pressure and/or temperature also cause bulk movements of air at the vertical direction, referred to as **upward or downward currents**.
- ❑ **Wind patterns across scales:**
 - ❑ Global scale → general atmospheric circulation
 - ❑ Continental scale → weather systems
 - ❑ Medium scale → orography, relief (friction effects at the Earth's surface)
 - ❑ Small scale → local obstacles (e.g., in urban environment)
- ❑ Narrow areas create a low pressure region causing the wind to move up to 50 times faster (**tunnel effect**); wind speed also increases significantly at hills and ridges, due to the fact that the wind becomes compressed on the windy side of the hill, and once the air reaches the ridge it can expand again as it soars down into the low pressure area on the lee side of the hill (**hill effect**).

Typical wind patterns

Sea breeze (occurs at daytime)

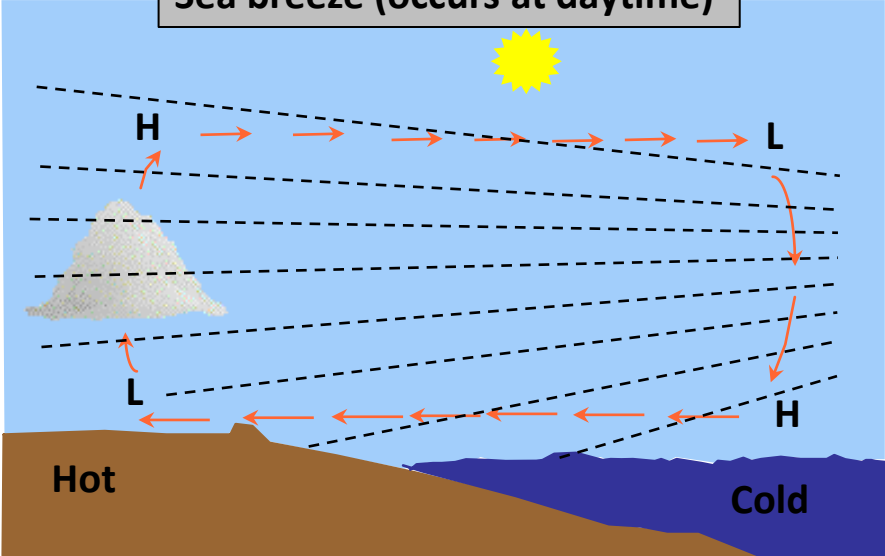

Land breeze (occurs at night)



Mountain waves (daytime)

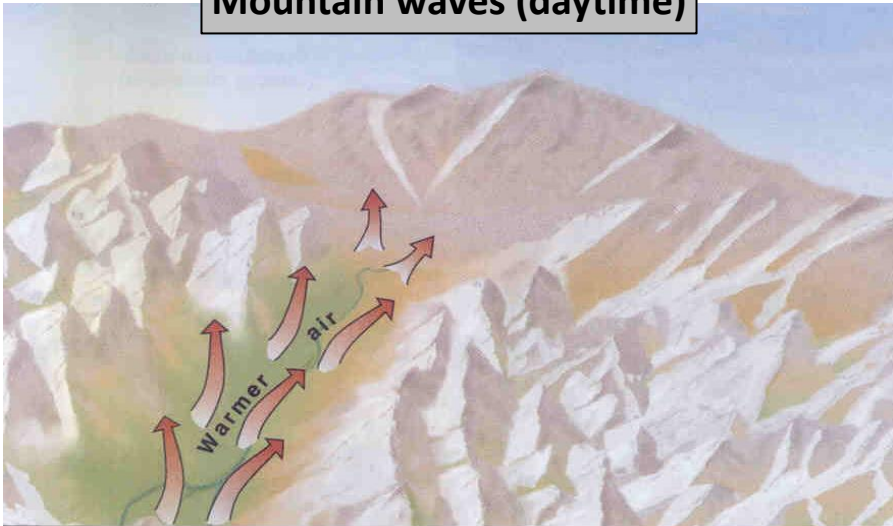

Mountain waves (night)

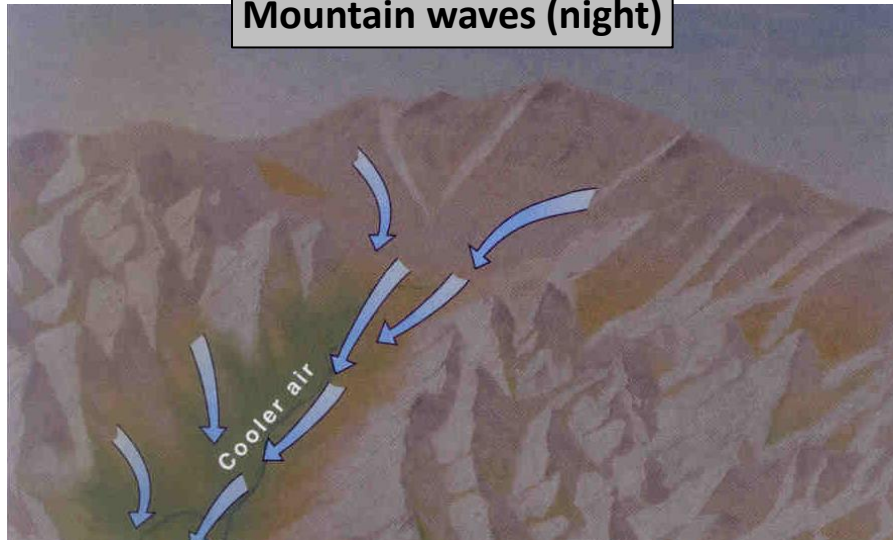

Wind measurement

Measured wind properties:

- wind direction (vector)
- wind speed (for convenience, it is typically reported at a 10 m height and averaged over a 10-minute time frame)
- wind gust (2-min peak speed)

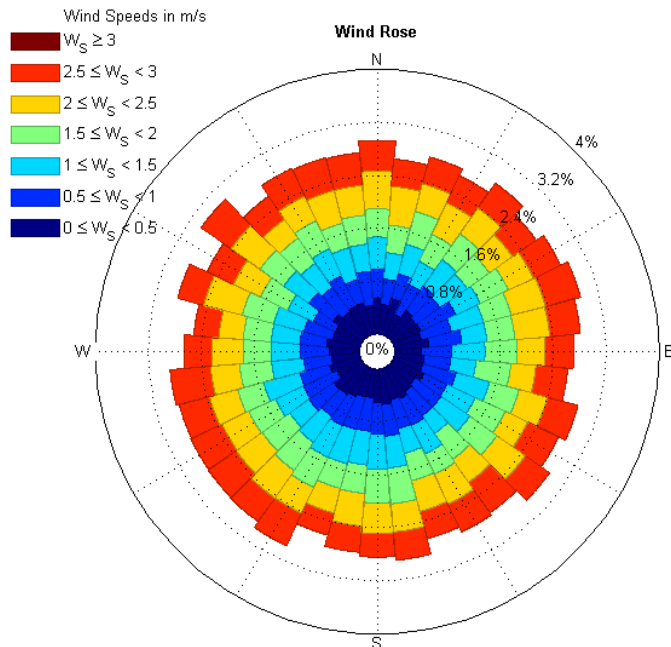

Representation of statistical distribution of wind speed per direction (wind rose)

General wind classifications (Beaufort scale)

| B | Classification | m/s | km/h | knots |
|----|-----------------|-----------|---------|-------|
| 0 | Calm | 0.0-0.2 | < 1 | < 1 |
| 1 | Light air | 0.3-1.5 | 1-5 | < 1 |
| 2 | Light breeze | 1.6-3.3 | 6-11 | 4-6 |
| 3 | Gentle breeze | 3.4-5.4 | 12-19 | 7-10 |
| 4 | Moderate breeze | 5.5-7.9 | 20-28 | 11-16 |
| 5 | Fresh breeze | 8.0-10.7 | 29-38 | 17-21 |
| 6 | Strong breeze | 10.8-13.8 | 39-49 | 22-27 |
| 7 | Moderate gale | 13.9-17.1 | 50-61 | 28-33 |
| 8 | Fresh gale | 17.2-20.7 | 62-74 | 34-40 |
| 9 | Strong gale | 20.8-24.4 | 75-88 | 41-47 |
| 10 | Whole gale | 24.5-28.4 | 89-102 | 48-55 |
| 11 | Storm | 28.5-32.6 | 103-117 | 56-63 |
| 12 | Hurricane | ≥ 32.7 | ≥ 118 | ≥ 64 |

- Knot → nmi/h (= 0.514 m/s)
- Beaufort to wind speed (m/s): $V = 0.836 B^{3/2}$
- **Typical range of wind turbine operation: 3.5 to 25.0 m/s (approx. 3 to 9 B)**

Vertical profile of wind speed

- The vertical distribution of horizontal mean wind speeds within the lowest portion of the planetary boundary layer, under neutral stability conditions, is given by:

$$u_z = \frac{u_*}{\kappa} \ln \left(\frac{z-d}{z_0} \right)$$

where u_* is the friction velocity (m s^{-1}), κ is the Von Kármán constant (~ 0.41), d is the zero plane displacement (m), and z_0 is a **surface roughness** parameter (m).

- **Zero-plane displacement** is the height above the ground at which zero speed is achieved as result of flow obstacles (approximated as 2/3 to 3/4 of the average height of obstacles).
- Roughness length, z_0 , is a corrective measure to account for friction effects to wind flow due to terrain obstacles (**very sensitive parameter**).
- In order to estimate the mean wind speed u_2 at a height z_2 based on a known (measured) value u_1 at a height z_1 , the formula is rearranged as:

$$\frac{u_2}{u_1} = \ln \left(\frac{z_2}{z_0} \right) / \ln \left(\frac{z_1}{z_0} \right)$$

- Power-type wind profile law (valid for $z > 100$ m):

$$u_2 = u_1 (z_2/z_1)^a$$

where a is the **Hellmann exponent** (typical value $a = 0.11$; applied to offshore wind parks)

Typical values of surface roughness z_0 (cm)

| | |
|-------------------------------|------------|
| Ice | 0.001 |
| Water surface | 0.01-0.06 |
| Open sea, fetch at least 5 km | 0.02 |
| Grass up to 1-10 cm | 0.1-0.2 |
| Open flat terrain | 3 |
| Crops of 10-50 cm | 2-5 |
| Vegetation up to 1-2 m | 20 |
| Trees of height 10-15 m | 40-70 |
| Suburb, forest | 100 |
| City center, buildings | ≥ 200 |

Variability of wind speed across scales

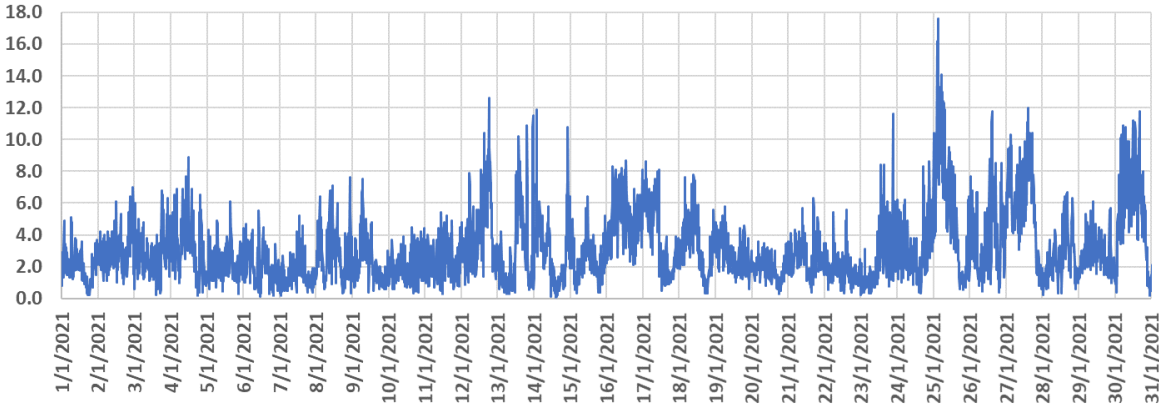

10 min wind speed data at Aktion (January 2021)

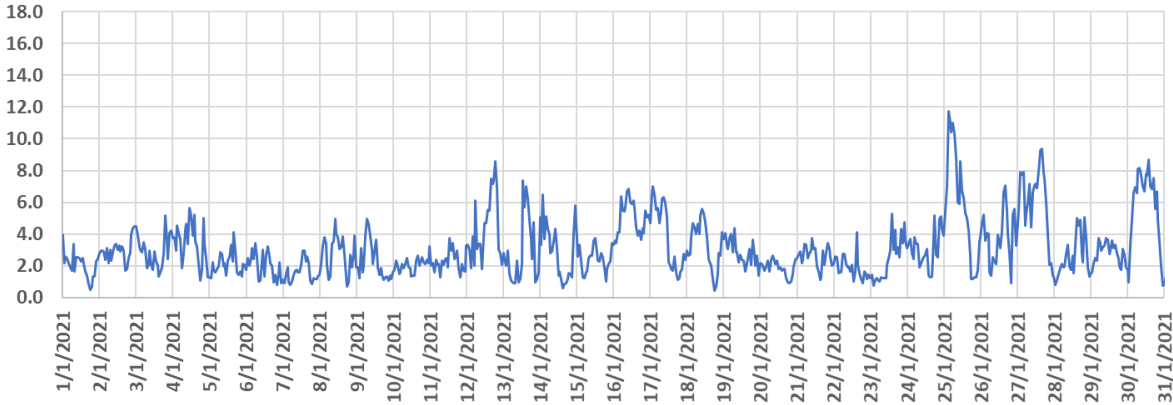

Mean hourly wind speed data at Aktion (January 2021)

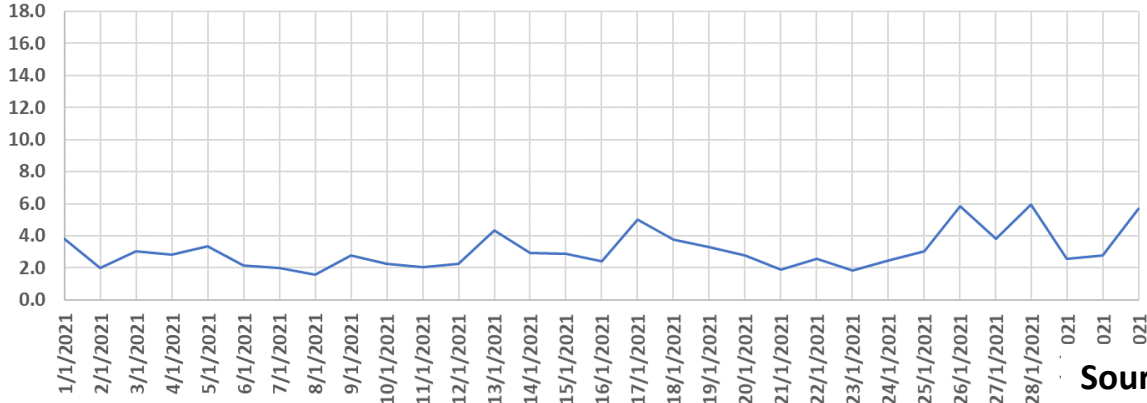

Mean daily wind speed data at Aktion (January 2021)

Source: <https://system.openhi.net/stations/1427/>

Statistical analysis of wind speed data

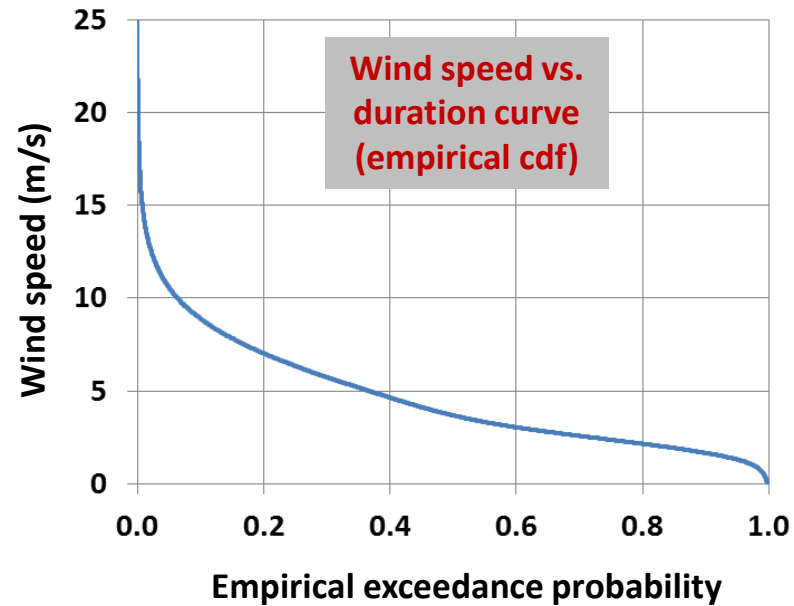
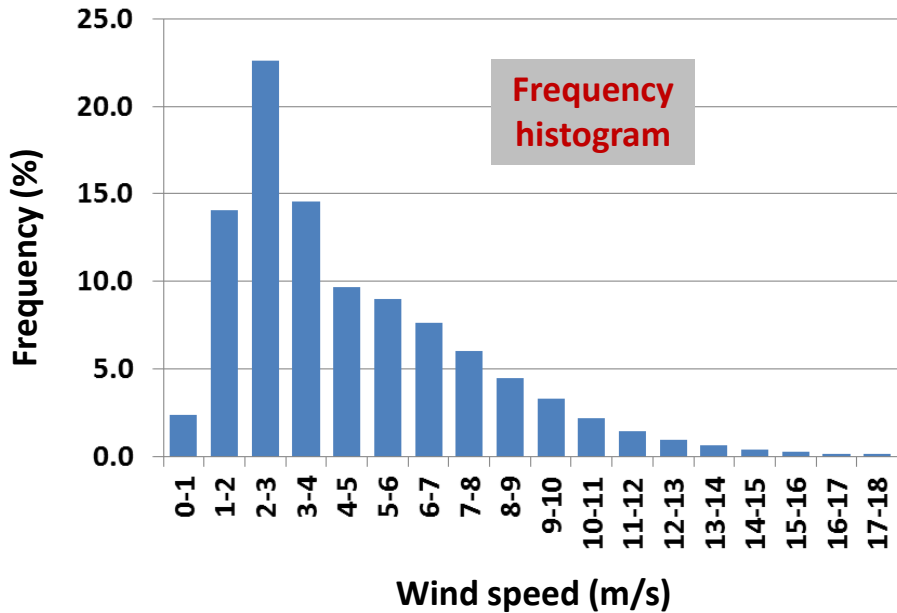
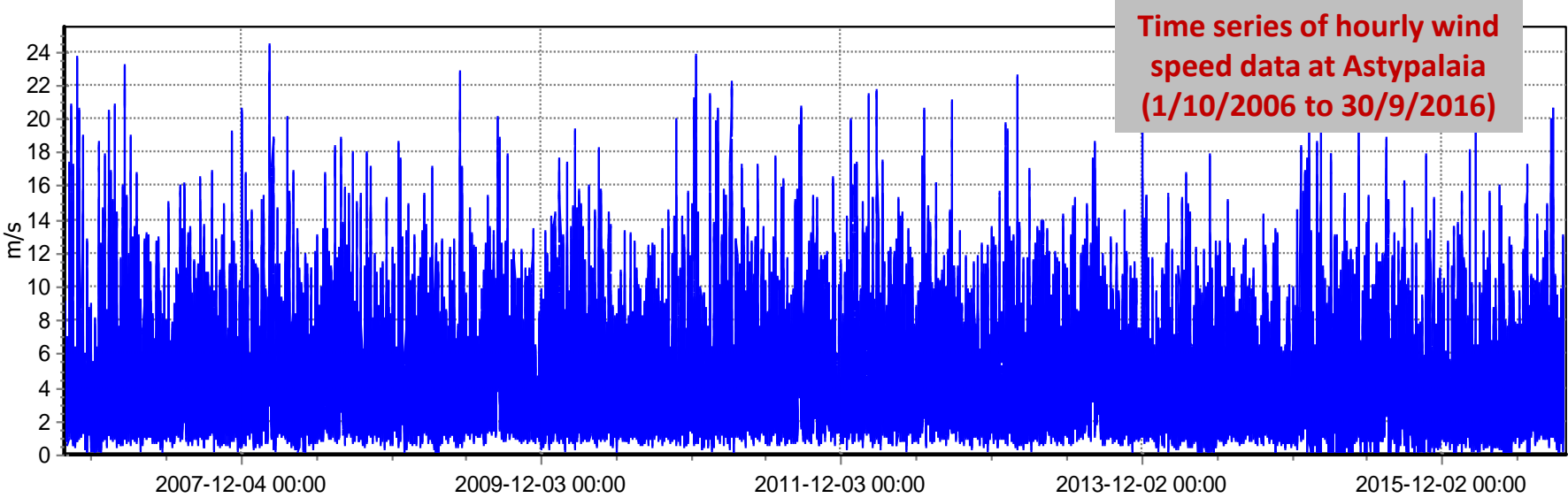

Statistical analysis per season and hour (Raches, Ikaria)

Probability Density Functions (PDF) - Histogram - Sample consisting from values of the month: Αύγουστος

— Normal — LogNormal

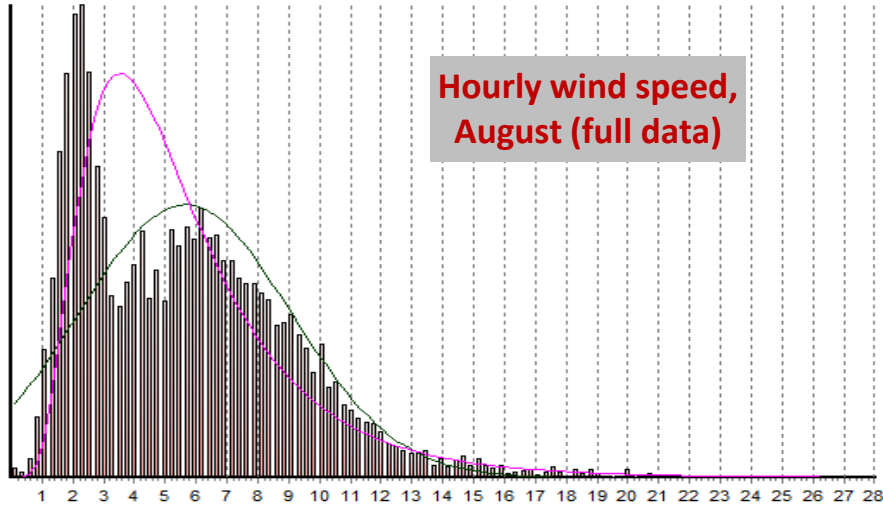

Probability Density Functions (PDF) - Histogram - Sample consisting from values of the month: Δεκέμβριος

— Normal — LogNormal

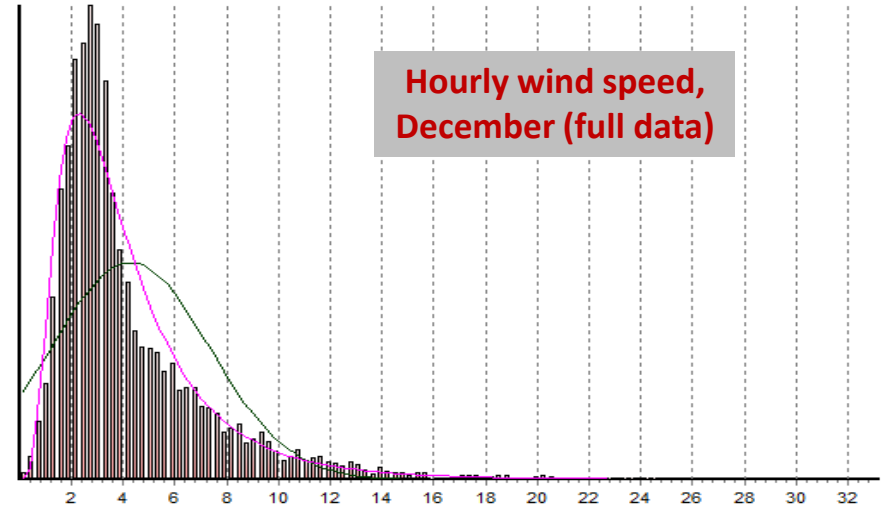

Probability Density Functions (PDF) - Histogram

— Normal — LogNormal

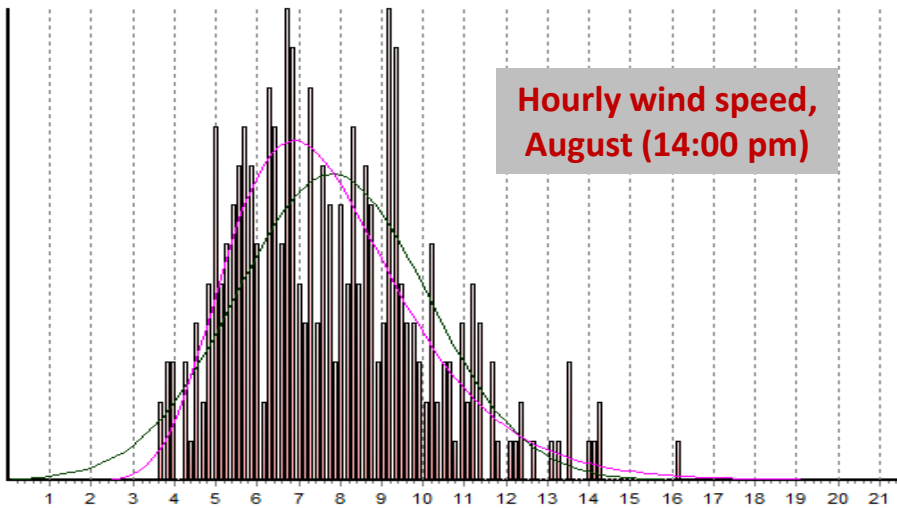

Probability Density Functions (PDF) - Histogram

— Normal — LogNormal

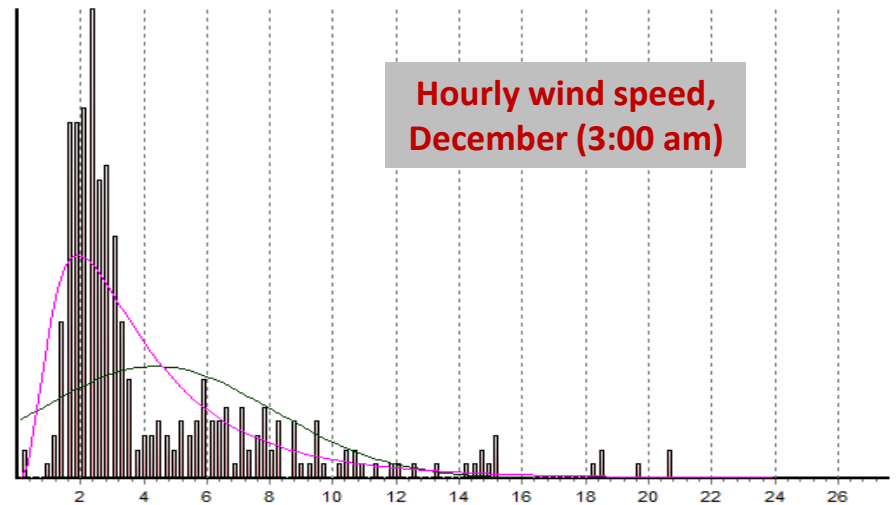

The “double” periodicity of wind

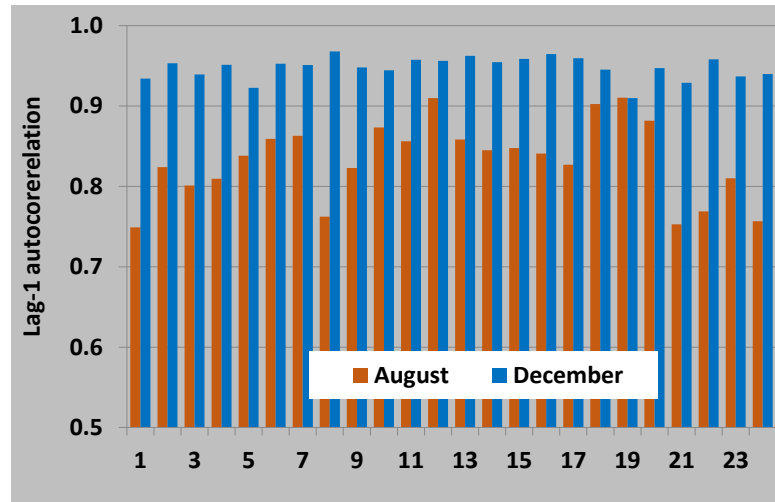
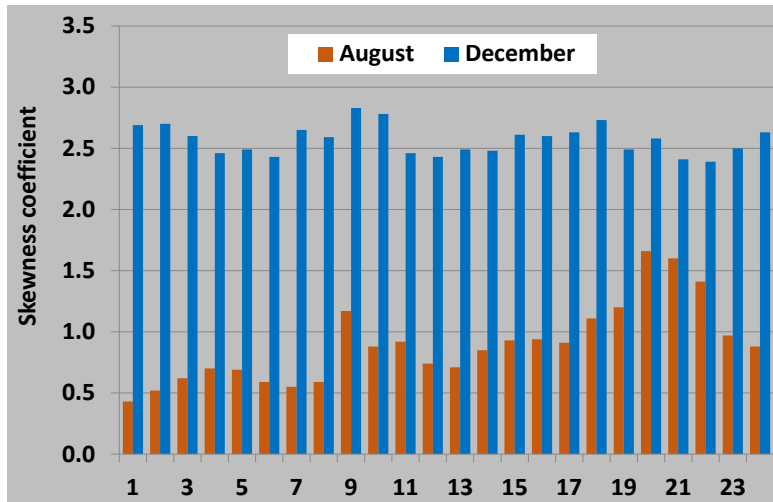
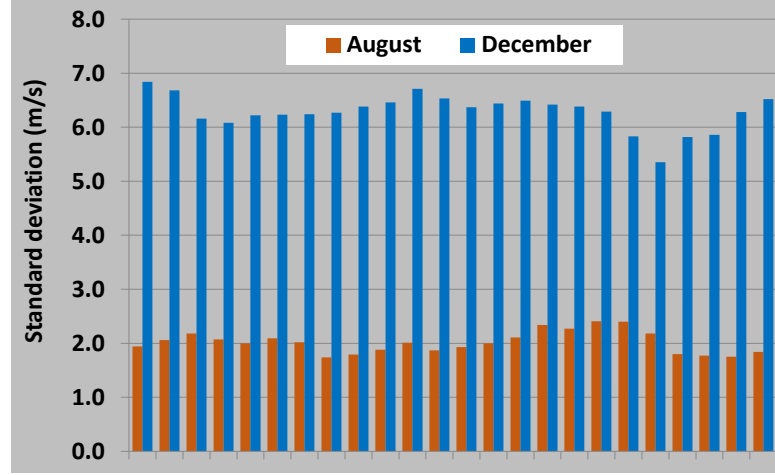
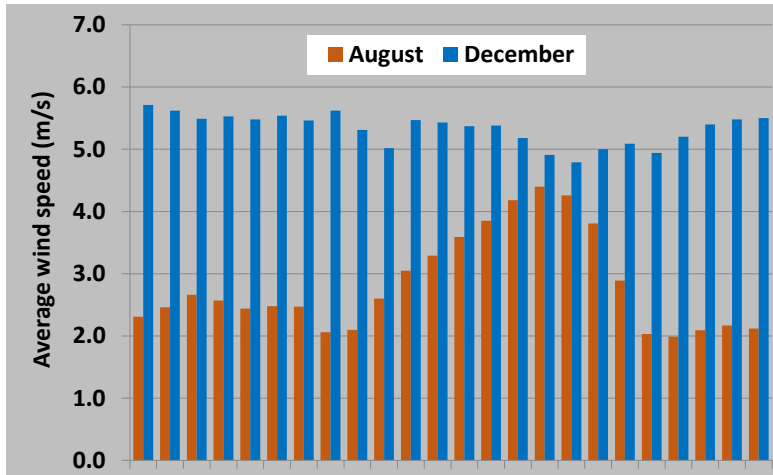

The wind speed process at fine time scales (e.g., hourly) is characterized by significant peculiarities, since its statistical behavior changes both across seasons (months) as well as within the daily cycle – an attribute referred to as **double periodicity**.

Aeolic potential over Greece

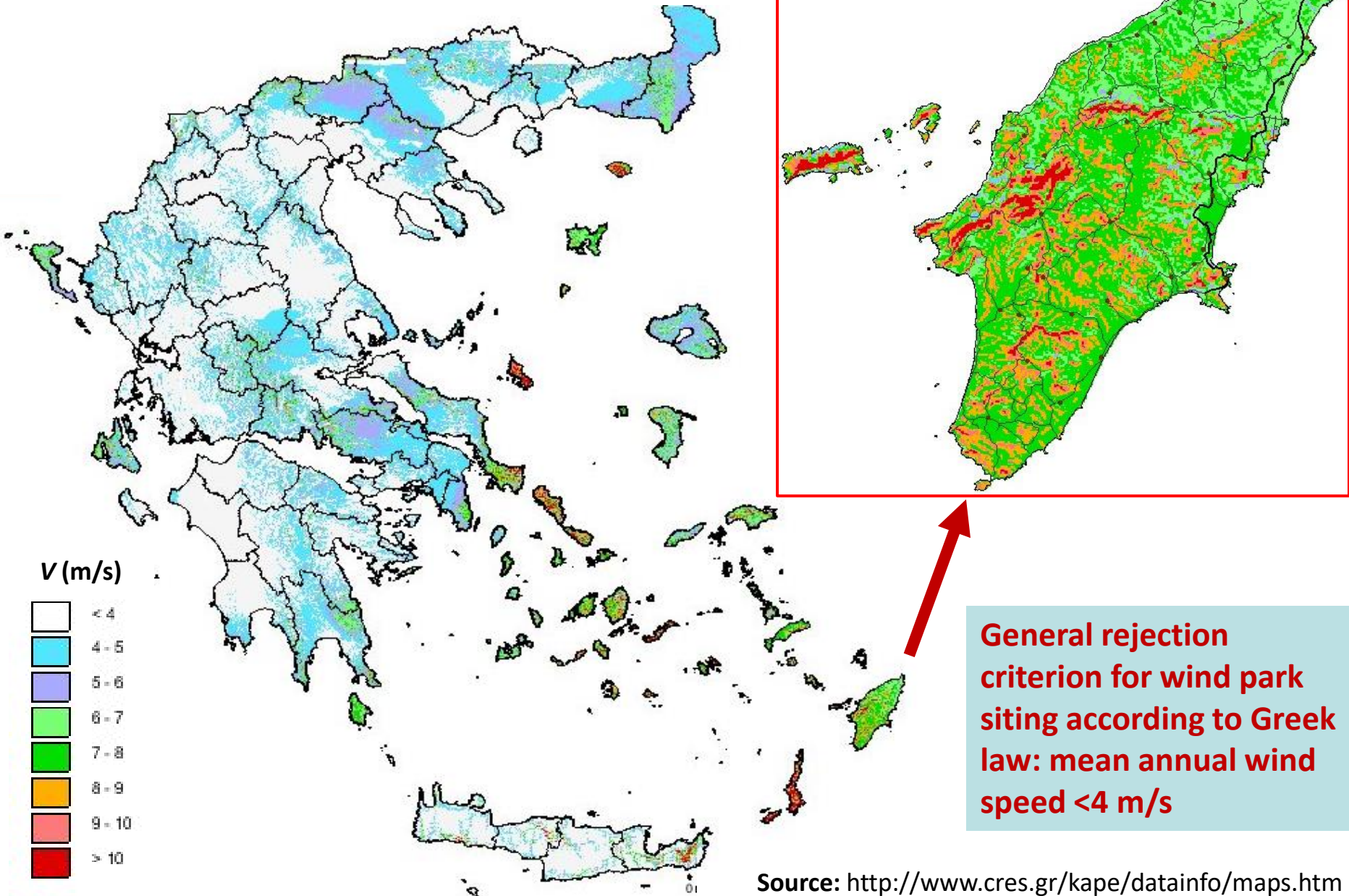

Source: <http://www.cres.gr/kape/datainfo/maps.htm>

Physics of wind power

- The power content in a cylindrical column of free unobstructed air moving at a constant speed V is the rate of change in its kinetic energy, i.e. $P_0 = \frac{dE}{dt}$.
- Kinetic energy of an air mass m moving with speed V :

$$E = \frac{m V^2}{2} \rightarrow \frac{dE}{dt} = \frac{1}{2} \left(2mV \frac{dV}{dt} + V^2 \frac{dm}{dt} \right)$$

- Mass flow of air through a disc of area A :

$$\frac{dm}{dt} = \rho V A = \rho V \frac{\pi D^2}{4}$$

where ρ is the air density (1.225 kg/m^3).

- The **theoretical wind power** is:

$$P_0 = \frac{\rho \pi D^2 V^3}{8}$$

- The effective usable wind power is less than the theoretical, as the wind speed behind a wind turbine can not be zero, since no air could follow. Therefore, only **part of the theoretical wind energy can be converted to mechanical energy**.

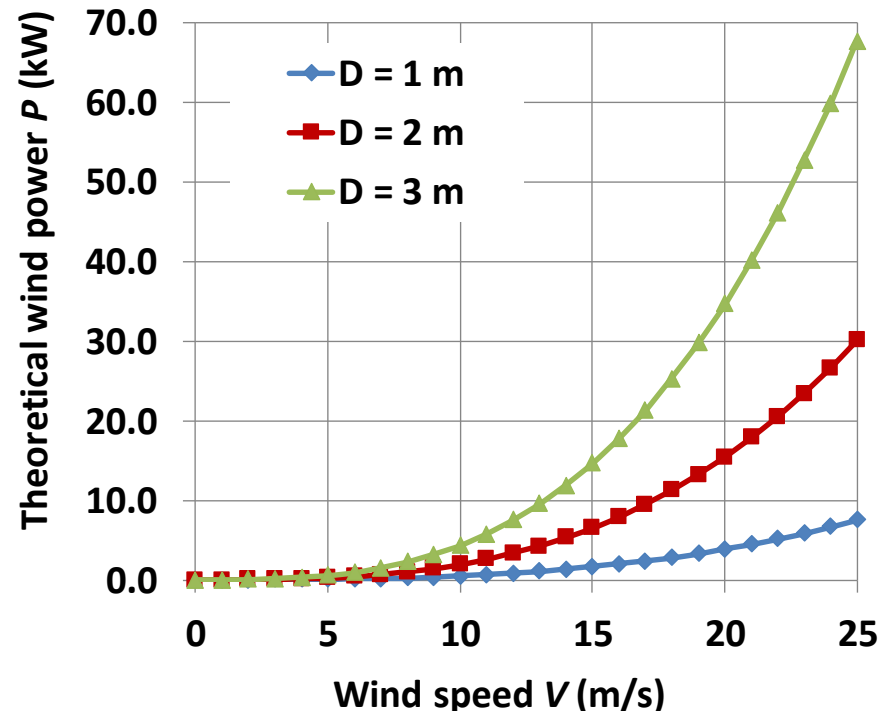
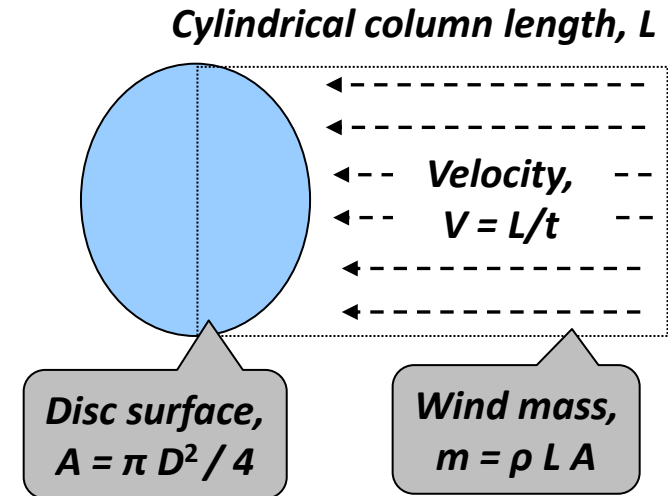

Conversion of wind power to mechanical power (1)

- **Assumption 1:** The wind rotor is an **ideal energy converter**, thus it does not possess a hub, while it possesses an infinite number of rotor blades that do not cause any drag resistance to the wind flowing through them.
- **Assumption 2:** Uniformity is assumed over the whole area swept by the rotor, and the speed of the air beyond the rotor is considered to be axial.
- Let V_1 be the wind speed far enough from the rotor, which is reduced to V_2 , behind it, and let V_A be the speed in front of it. The wind energy absorbed by the rotor is converted to mechanical energy, i.e.:

$$E = E_1 - E_2 = \frac{m (V_1^2 - V_2^2)}{2} \quad (1)$$

- By setting $V_1 = \alpha V_A$ and $V_2 = \beta V_A$ we get:

$$E = \frac{m V_A^2 (\alpha^2 - \beta^2)}{2} = \frac{\rho L A V_A^2 (\alpha^2 - \beta^2)}{2} \quad (2)$$

- For constant air flow (speed) $V_A = dL/dt$, the mechanical power is:

$$P = \frac{dE}{dt} = \frac{\rho A V_A^3 (\alpha^2 - \beta^2)}{2} \quad (3)$$

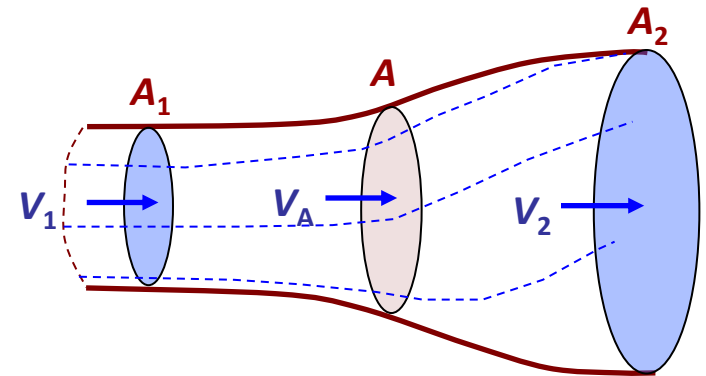

Remarks

- Since $V_1 \geq V_A \geq V_2$, we get $\alpha \geq 1$ and $\beta \leq 1$.
- If there do not exist blades, the air flow is free ($V_1 = V_A = V_2$), and any mechanical energy is produced (thus $\alpha = \beta = 1$).

Conversion of wind power to mechanical power (2)

- According to the **momentum equation**, the force acting to the blades is:

$$F = m \frac{dV}{dt} = \rho A V_A (V_1 - V_2) = \rho A V_A^2 (\alpha - \beta) \quad (4)$$

- The rate of work produced by F (**power**) is:

$$P = \frac{dE}{dt} = \frac{d(F L)}{dt} = F \frac{dL}{dt} = F V_A = \rho A V_A^3 (\alpha - \beta) \quad (5)$$

- By combining (3) and (5) we get:

$$P = 0.5 \rho A V_A^3 (\alpha^2 - \beta^2) = \rho A V_A^3 (\alpha - \beta) \Rightarrow \alpha + \beta = 2 \quad (6)$$

- Since $V_1 = \alpha V_A$ and $V_2 = \beta V_A$ we get:

$$\alpha V_A + \beta V_A = 2 V_A \Rightarrow V_1 + V_2 = 2 V_A \Rightarrow V_A = (V_1 + V_2) / 2 \quad (7)$$

- By combining (5) and (6) we get:

$$P = 2 \rho A V_A^3 (\alpha - 1) \quad (8)$$

- By substituting with the wind speed entering the rotor, we get the final expression of the **theoretical mechanical energy**, i.e.:

$$P = 2 \rho A (V_1 / \alpha)^3 (\alpha - 1) = 2 \rho A V_1^3 (\alpha^{-2} - \alpha^{-3}) \quad (9)$$

Theoretical efficiency – Betz limit

- The performance coefficient (efficiency) is the dimensionless ratio of the extractable mechanical power P to the kinetic power P_0 available in the undisturbed wind stream, i.e.:

$$c = P/P_0 = 4(a^{-2} - a^{-3}) \quad (10)$$

- The efficiency is maximized for:

$$\frac{\partial c}{\partial a} = 0 \Rightarrow -2a^{-3} + 3a^{-4} = 0 \Rightarrow a^* = 3/2 \quad (11)$$

- By substituting to (10), the **maximum efficiency of the ideal wind machine** (referred to as **Betz limit**) is:

$$c_{max} = 2(2/3)^3 = 16/27 = 0.593 \quad (12)$$

- The **maximized power production** is:

$$P_{max} = (2/3)^3 \rho A V_1^3 = 0.296 \rho A V_1^3 \quad (13)$$

- For $\alpha^* = 3/2$, from eq. (6) we get $\beta^* = 1/2$, thus the optimal speed behind the rotor is:

$$V_2 = V_1/3 \quad (14)$$

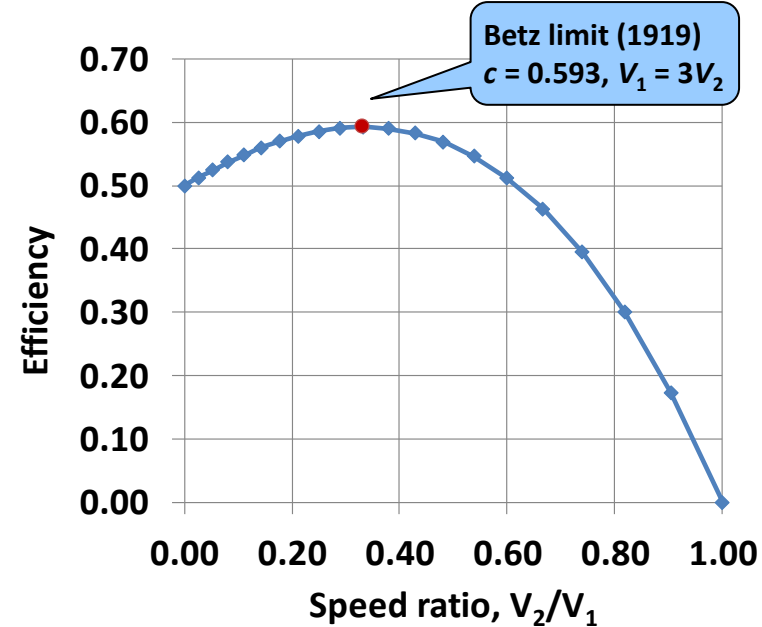

Remarks

- From eq. (10) we get that the efficiency becomes zero for $\alpha = 1$ ($V_1 = V_2$), thus for fully undisturbed air flow.
- When the air flow is totally interrupted by the blades, thus the outflow speed is zero ($V_2 = 0$, $\alpha = 2$, $\beta = 0$), the efficiency is $c = 0.50$.
- Generally, $V_2 / V_1 = (2 - \alpha)/\alpha$

Wind turbine efficiency – Power curves

- The Power Coefficient (C_p) is a measure of **wind turbine efficiency**, defined as the ratio of actual electric power, P_e , produced by a wind turbine divided by the total wind power, P_0 , flowing into the turbine blades **at specific wind speed**, i.e.:

$$C_p(V) = \frac{P_e}{P_0} = \frac{8 P_e(V)}{\rho \pi D^2 V^3}$$

- C_p represents the **combined efficiency of the various wind power system components**, which include the turbine blades, the shaft bearings and gear train, the generator and power electronics. It can be generally expressed as the product of three components:
 - Blade aerodynamic efficiency (< Betz limit)
 - Mechanical efficiency
 - Electrical efficiency
- For a specific turbine, C_p is measured in the laboratory, and provided by the manufacturer, by means of nomographs, called **power curves**.
- Characteristic quantities are:
 - the **nominal power**, P_{max}
 - the **cut-in and cut-out speeds** ($V_{max} < 25$ m/s, for safety)

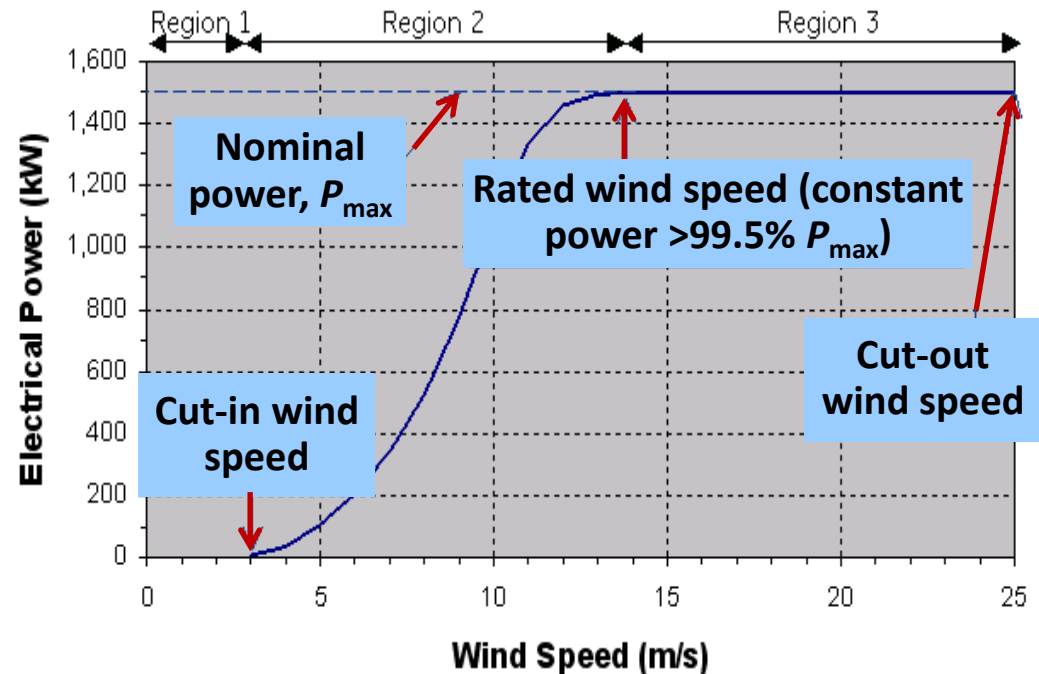

Insight to power curves

Electric Power & Cp vs. Wind Speed

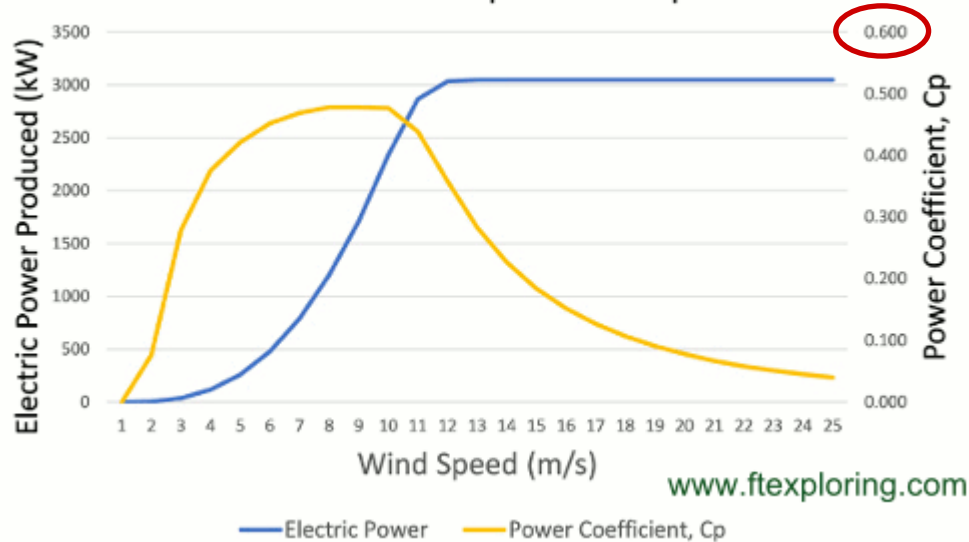

- The power coefficient is **maximized close to the lowest wind speed value providing the nominal power**, and cannot exceed the Betz limit (59.3%).
- After this characteristic point, the power coefficient **decreases rapidly**, since the deviation of the actual electric power from the theoretical wind power increases substantially (given that P_0 is a function of the wind speed raised to the 3rd power).
- Modern machines exhibit maximum efficiency up to 50% (average 35-45%).
- Actual power production may differ significantly from the theoretical one, due to environmental facts as well as human manipulations in the field.

Wind Power In & Actual Electric Power Produced vs Wind Speed

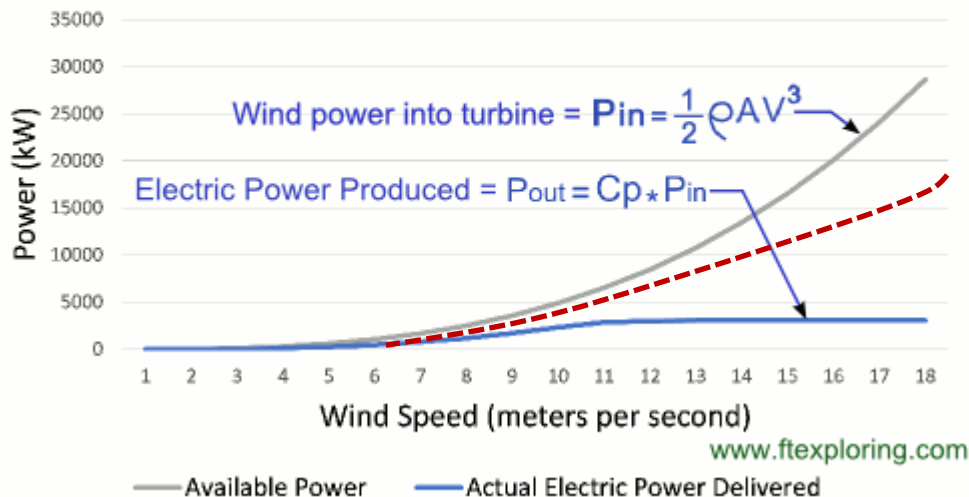

Estimation of wind energy production

- ❑ Wind data (wind speed, measured at height z_1)
 - ❑ **Full data** (time series at fine time scales, e.g. hourly)
 - ❑ **Summary data** (mean monthly values, histogram)
- ❑ Transfer to the height of the rotor, z_2 (preferably using the logarithmic profile law)
- ❑ Estimation of wind power production, using the power curve of the turbine:
 - ❑ **Analytically** (via simulation), if full time series are available;
 - ❑ **Empirically**, considering the average time interval per year that correspond to each wind speed class (produced energy per class = hours per class \times electric power provided for the average speed of the corresponding class)
- ❑ Empirical approaches do not require the sequence of wind speed values, only their **statistical regime**.
- ❑ Simulation is essential in case of:
 - ❑ **Autonomous systems**, where the wind energy production has to be contrasted with demand, in order to estimate energy surpluses and deficits;
 - ❑ **Hybrid systems**, where multiple power sources are mixed;
 - ❑ **Real-time operation** of wind power systems, requiring wind speed forecasts.
- ❑ In all approaches the **time scale of analysis** plays important role – the finer the scale, the more accurate are the results.

Example using the wind speed histogram

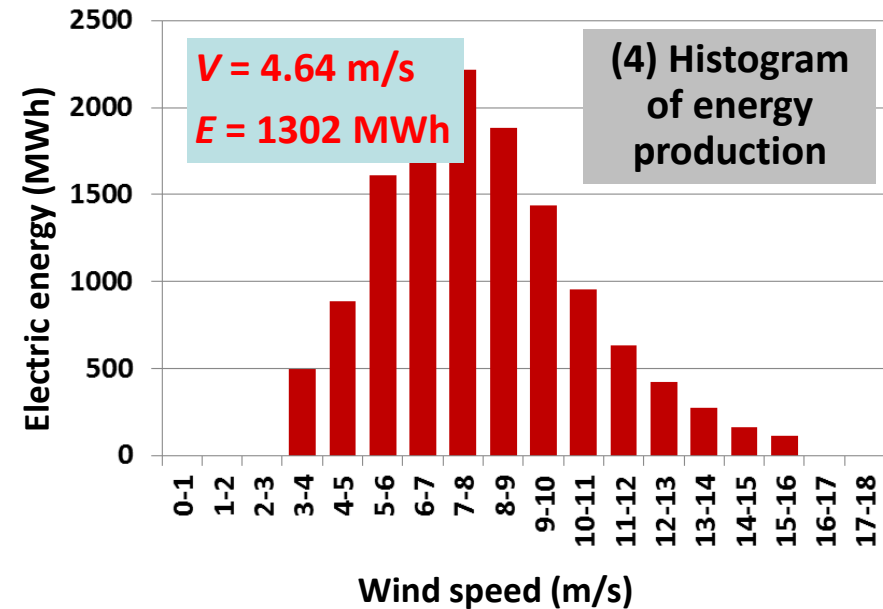
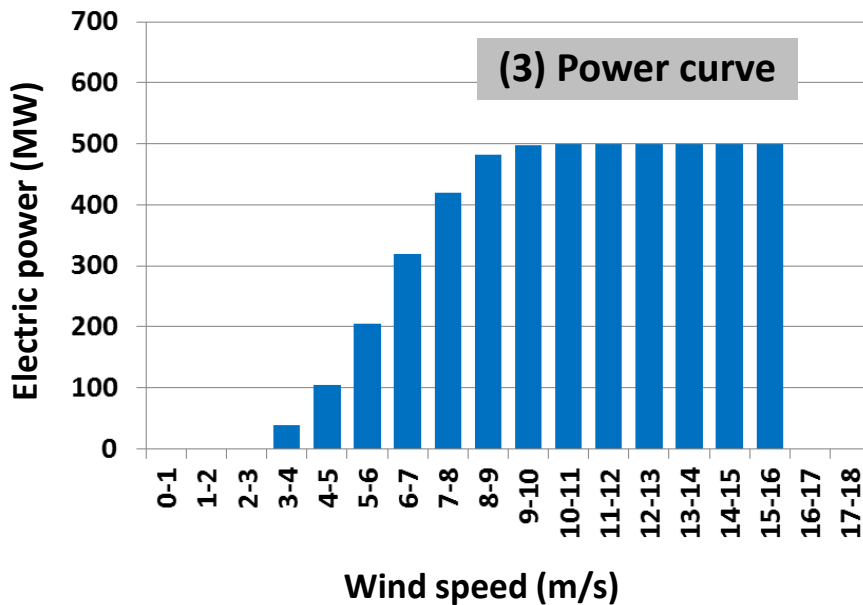
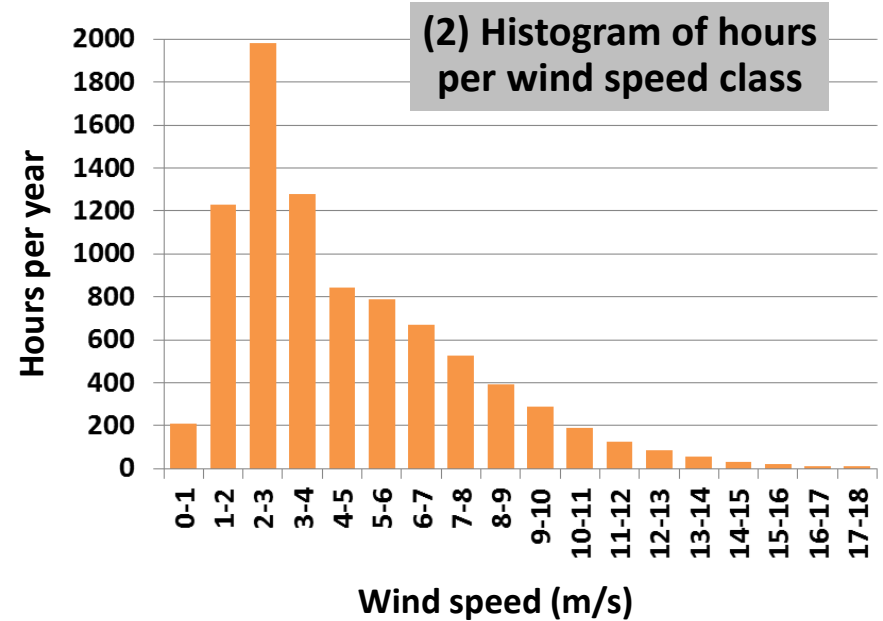
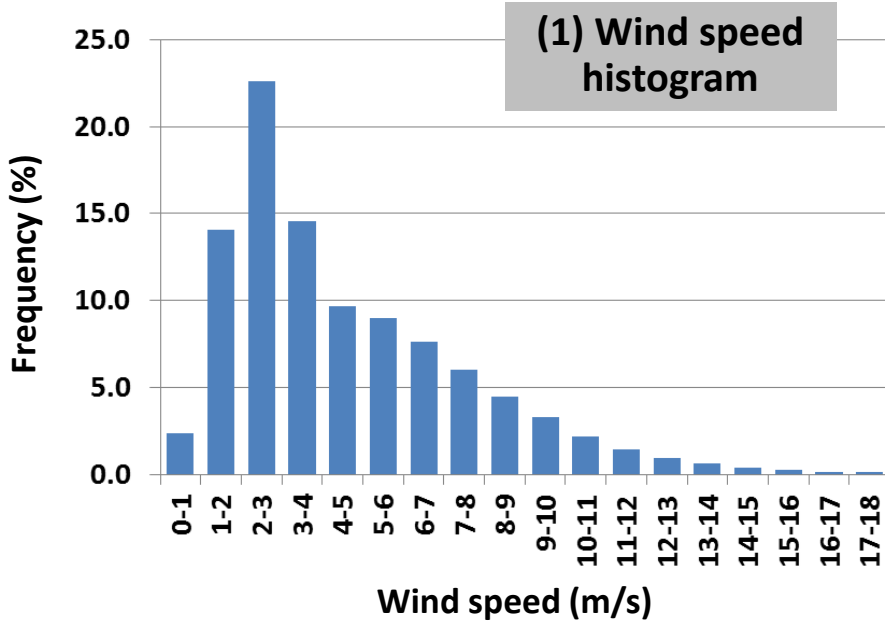

The distribution of wind speed matters!

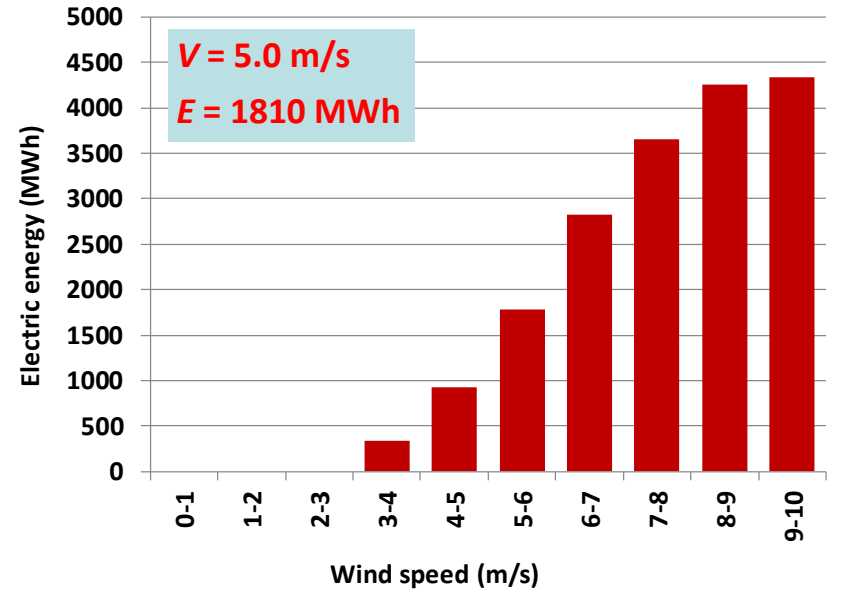
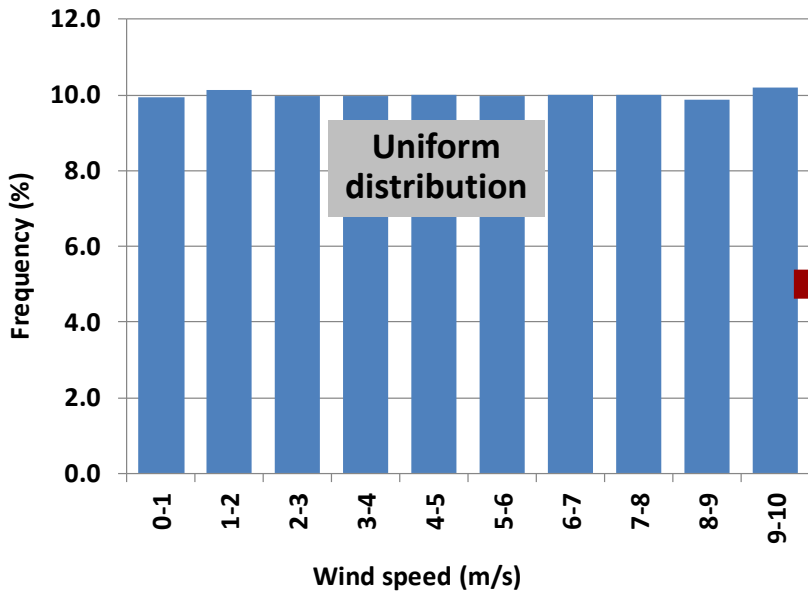
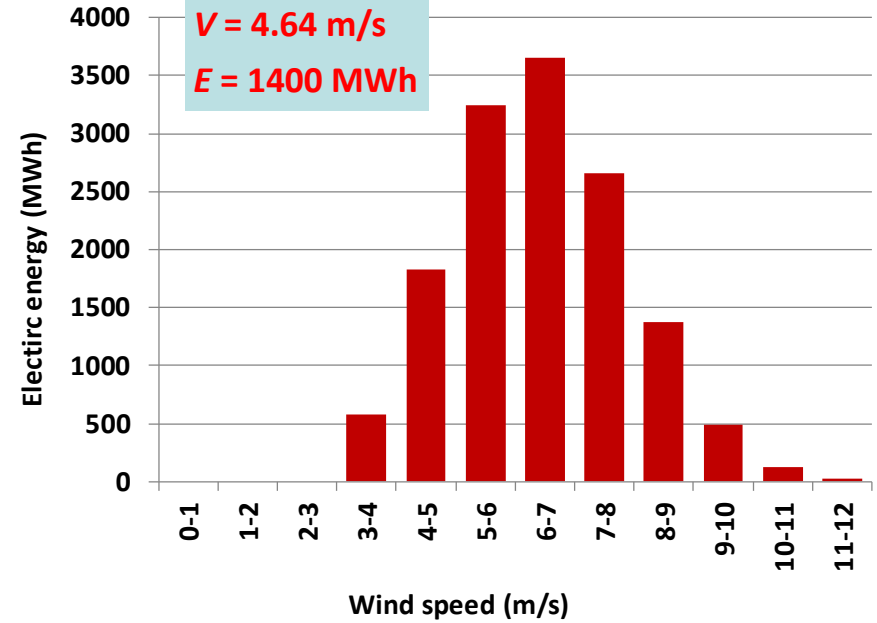
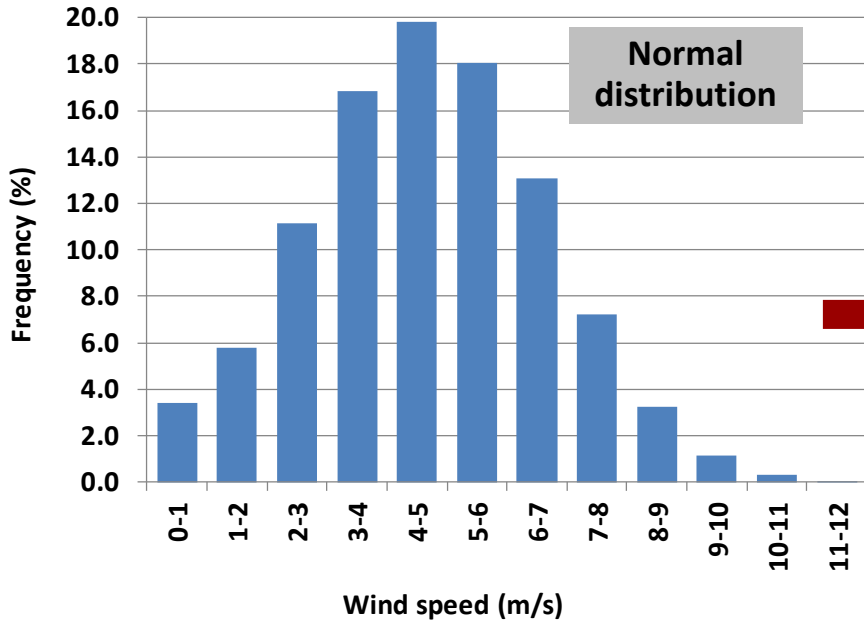

Simulation example

- ❑ Turbine type: Vestas V39, nominal power capacity 500 kW;
- ❑ Hourly time series of wind speed and energy demand for years 2006-2016 (Astypalaia);
- ❑ Wind conversion factor: 1.57 (blade height 53 m);
- ❑ Installation of 6 wind turbines (total capacity 3.0 MW), to cover the hourly peak energy demand (2.72 MWh);
- ❑ Statistical analysis using the wind speed histogram;
- ❑ Simulation at three temporal levels (hourly, daily, monthly), which allow estimating:
 - ❑ the energy **deficits** and **surpluses**, at each time step;
 - ❑ the overall **reliability** of the system.

Remark: The reliability of an energy system (or its complementary notion, i.e. failure probability) can be empirically estimated by accounting for the **frequency of energy deficits**, i.e. number of time steps that the energy production cannot meet the corresponding demand divided by the total number of simulated time steps. Normally, the desirable reliability of an energy system, in hourly basis, should tend to 100%.

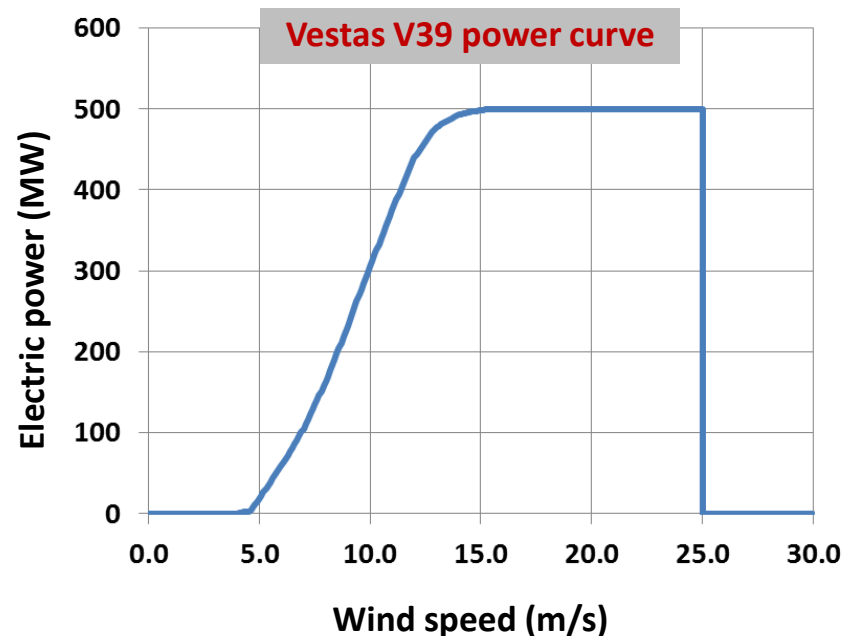

Results of simulations

| | Full data (10 years) | | | Data of first three years | | |
|--------------------------------|----------------------|-------|---------|---------------------------|-------|---------|
| | Hourly | Daily | Monthly | Hourly | Daily | Monthly |
| Mean energy production (MWh) | 7873 | 7141 | 6591 | 8367 | 7908 | 7601 |
| Mean demand (MWh) | 6306 | 6306 | 6312 | 6305 | 6306 | 6311 |
| Mean deficit (MWh) | 3282 | 2705 | 900 | 3168 | 2419 | 402 |
| Mean surplus (MWh) | 4849 | 3540 | 1180 | 5230 | 4021 | 1691 |
| Frequency of energy deficits | 0.600 | 0.627 | 0.500 | 0.581 | 0.586 | 0.389 |
| Frequency of energy surpluses | 0.400 | 0.373 | 0.500 | 0.419 | 0.414 | 0.611 |
| Frequency of turbine operation | 0.687 | 0.931 | 1.000 | 0.704 | 0.946 | 1.000 |

Empirically-derived mean annual energy production (using the wind speed histogram: **7932 MWh**)

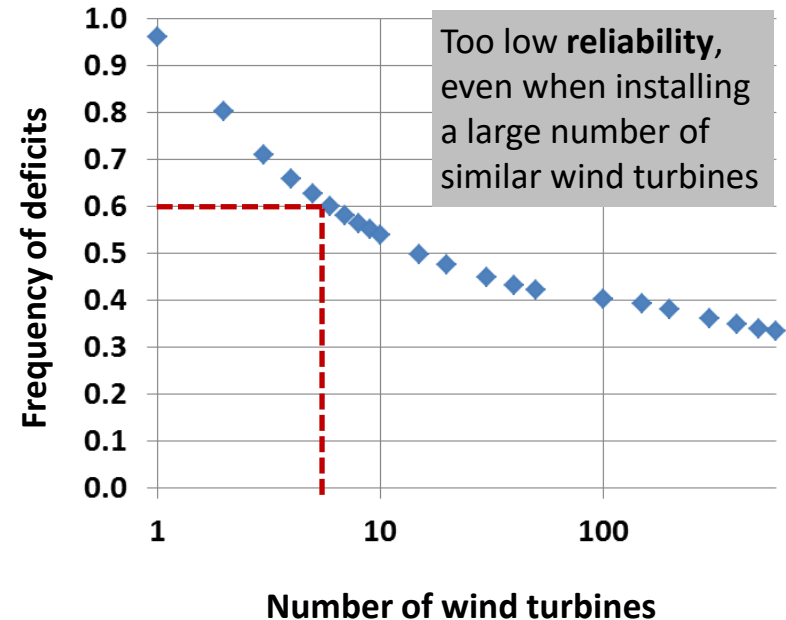
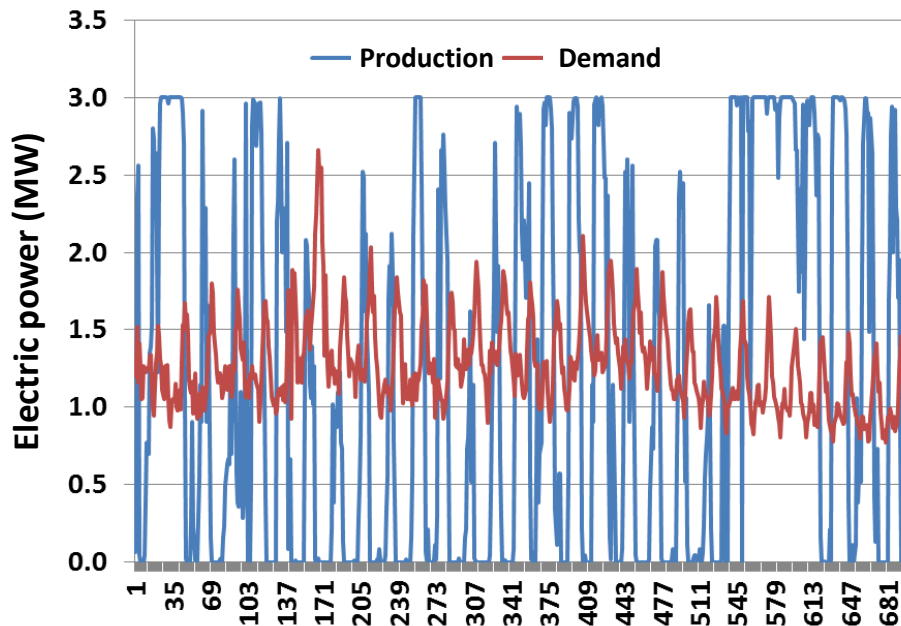

Wind farms: (macro)siting criteria and exclusion zones

Key technical criteria:

- ❑ Aeolic potential (preliminary analysis using mean annual or mean monthly data)
- ❑ Construction criteria (foundation conditions, earthquake regime)
- ❑ Distance from obstacles (hills, trees, buildings, etc.)
- ❑ Accessibility – distance from road and grid network (< 300 m)

Exclusion zones and associated buffer zones (Greek law):

- ❑ Protected landscapes (> 1000 m)
- ❑ Archaeological sites (> 1000 m)
- ❑ UNESCO sites (> 3000 m)
- ❑ Historical sites (no buffer)
- ❑ Urban areas & traditional settlements
 - ❑ > 2000 inhabitants: > 1000 m
 - ❑ < 2000 inhabitants: > 500 m
 - ❑ Traditional settlements: > 1500 m
- ❑ Tourism facilities (hotels, guesthouses) (> 1000 m)
- ❑ Proximity to airports (> 3000 m)
- ❑ Land use restrictions
 - ❑ Artificial surfaces
 - ❑ Industrial, commercial & transport units
 - ❑ Mine, dump & construction sites
 - ❑ Irrigated agricultural land
 - ❑ Wetlands
- ❑ Slope 25%
- ❑ Areas where the mean annual wind speed is less than 4 m/s

Wind farms: optimal design (micro-siting)

Typical issues accounted for:

- ❑ maximum installed capacity (e.g., due to grid connection);
- ❑ predominant wind direction;
- ❑ site boundary;
- ❑ distance from roads, dwellings, overhead lines, etc.;
- ❑ environmental constraints;
- ❑ location of noise-sensitive dwellings and assessment criteria;
- ❑ location of visually-sensitive viewpoints;
- ❑ location of dwellings, affected by flickering shadows cast by rotating blades;
- ❑ turbine minimum spacing as defined by the turbine supplier (depends on the prevailing wind);
- ❑ constraints associated with communication signals;

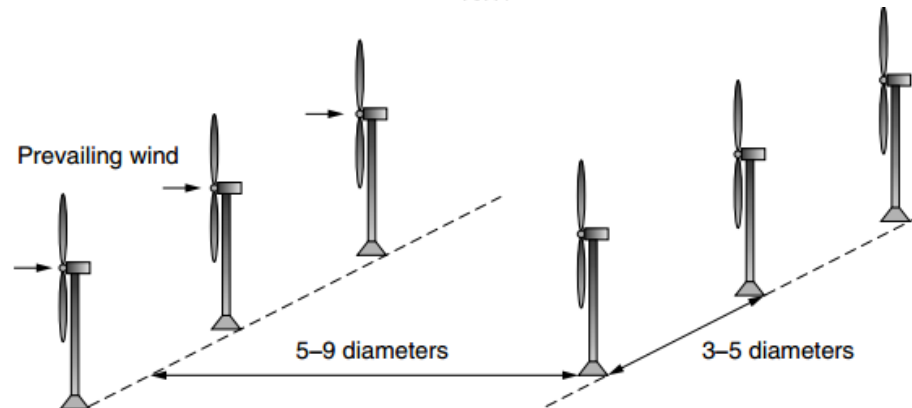
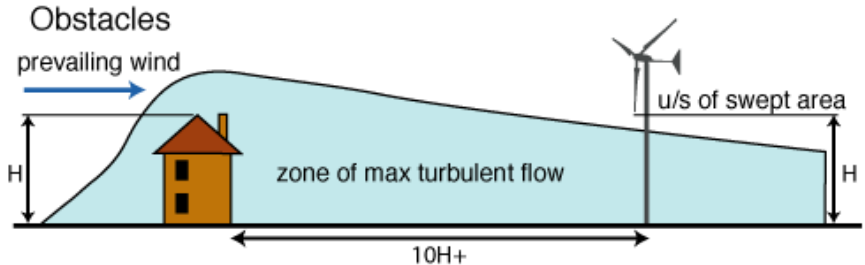
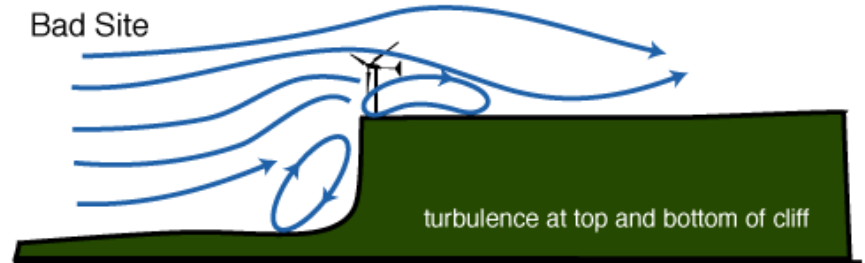
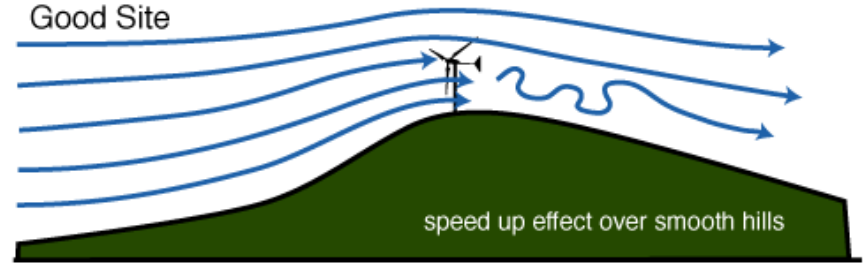

Pros and cons of wind energy

Advantages

- ❑ Technologically mature, economically competitive, fast and standardized installation;
- ❑ Very low operational cost (yet expensive set-up);
- ❑ Clean energy, with negligible impacts to the flora and fauna and minimal land requirements;
- ❑ Enhances energy independence and security.
- ❑ Contributes to the decentralization of the energy system, reducing energy transmission losses;

Disadvantages

- ❑ Uncertain and highly-fluctuating energy production, due to the inherent variability of the driving process, i.e. wind speed, at all scales (**non-controllable energy source**);
- ❑ Noise from machinery parts and the rotating blades (44 db in a distance of 200 m, for wind speed 8 m/s);
- ❑ Visual disturbance (aesthetic criterion – too subjective);
- ❑ Bird and bat collisions (very small percentage of deaths; modern technologies, e.g. ultrasonic boom boxes, prohibit from such threats);
- ❑ Construction of road networks in mountainous landscapes.